

DRAWING: LD-MTS01-607201

ISSUED: 16/12/2015

MODEL: Marine Table  
VARIANT: Standard Leg System

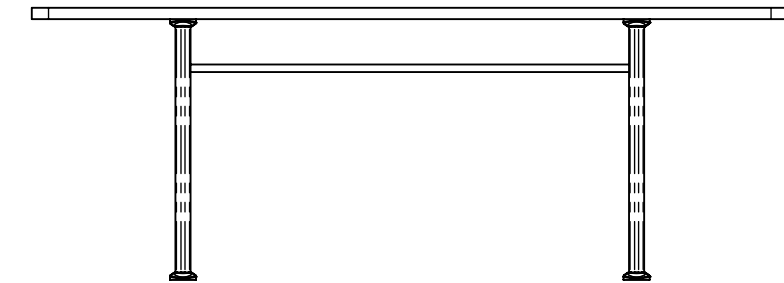

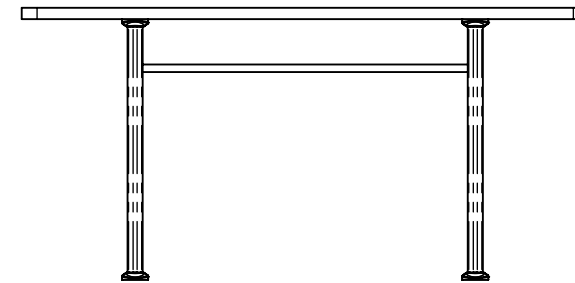
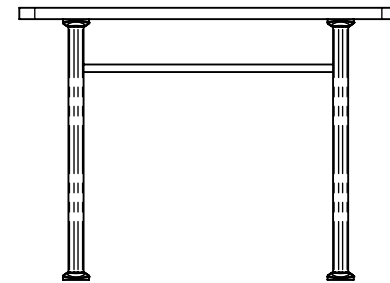
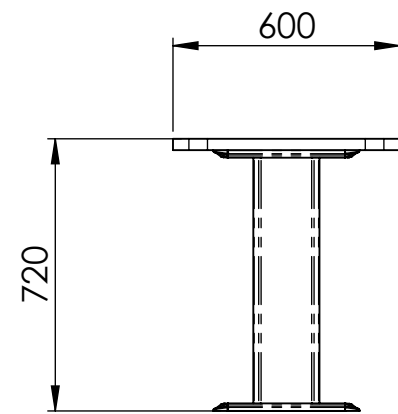
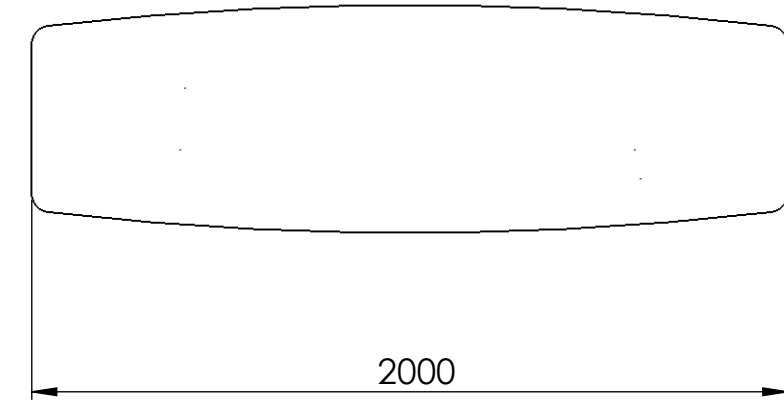
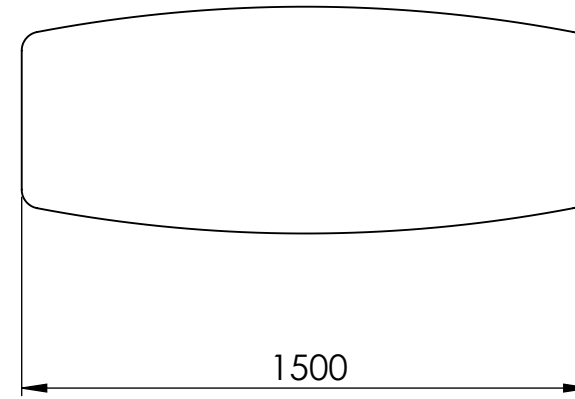
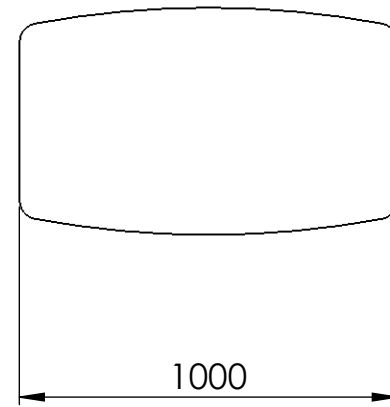
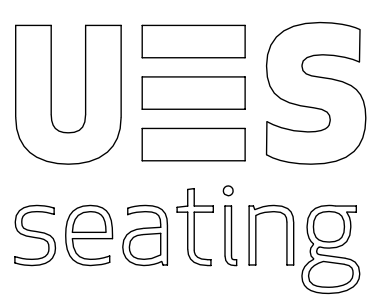

1:20 Scale  
Dimensions are in mm  
Tolerance  $\pm 10$  mm

A Division of UES International

DRAWING: LD-MTH01-607201

ISSUED: 16/12/2015

MODEL: Marine Table  
VARIANT: HSC Leg System

